

ALLOWANCE			MARK	DATE	DESCRIPTION OF REVISION	APPROVED
UNDER 3	± 0.1	△	. .			
3 TO 6	± 0.2	△	. .			
6 TO 18	± 0.3	△	. .			
18 TO 50	± 0.4	△	. .			
50 OVER	± 0.5	△	. .			

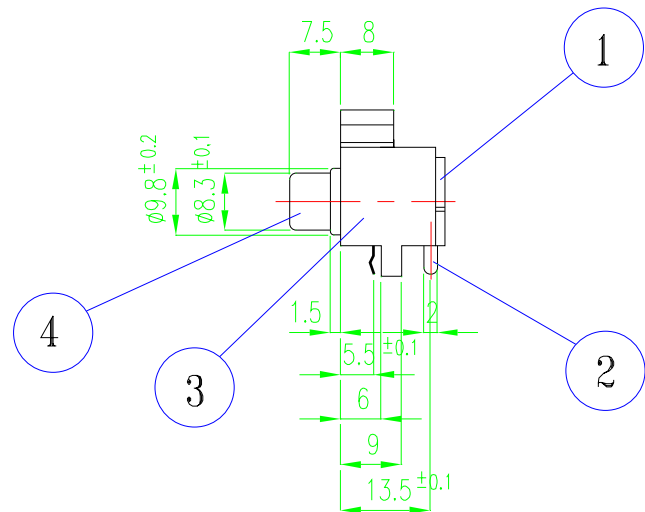

"E" DETAIL 2/1

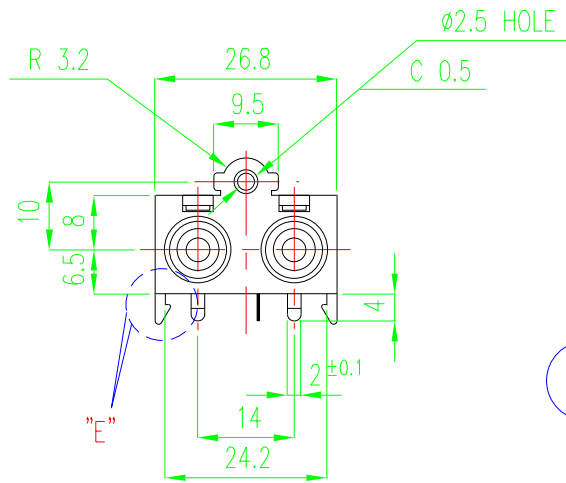
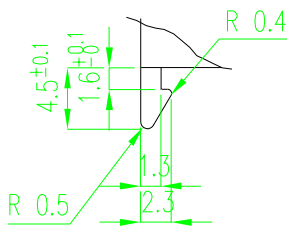

SCHEMATIC

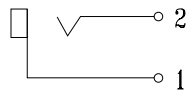

PCB-MTG

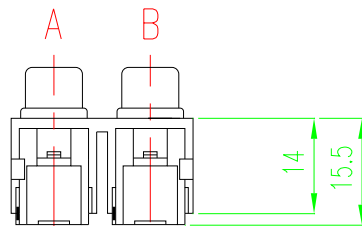
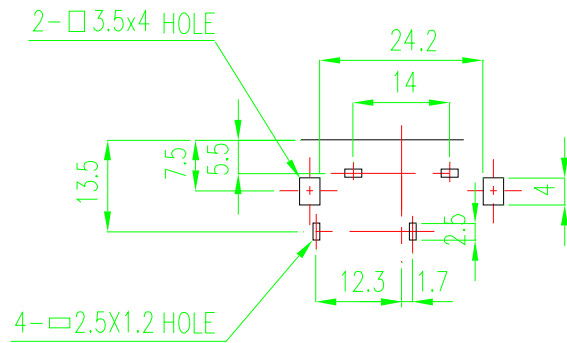

4	CAP-GROUND	C2600 1-0 0.4t	2	P146	NI-PLATING
3	COVER	ACETAL	1	M716	BLACK
2	PIN-S	C2680 H 0.5t	2	P147	NI-PLATING
1	BASE	ACETAL	2	M719	A:Red B:White
NO	PART NAME	MATERIAL	QUANTITY	PART NO	REMARKS

Vimex International Corp.
800-227-0075

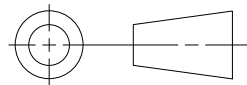

SCALE 1/1 DIMENSION m/m

DRAWING	CHECKED	JUDGING	APPROVED	NAME TITLE	PIN JACK BOARD (2P)
L.H.J	B. Emmerich			DRAWING NUMBER	JC0200090N
1991.5.10	2002.06.05				