

ALLOWANCE	MARK	DATE	DESCRIPTION OF REVISION	APPROVED
UNDER 3 ±0.1	▽	..		
3 TO 6 ±0.2	▽	..		
6 TO 18 ±0.3	▽	..		
18 TO 50 ±0.4	▽	..		
50 OVER ±0.5	▽	..		

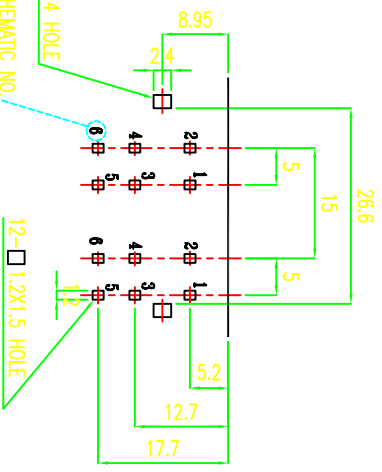
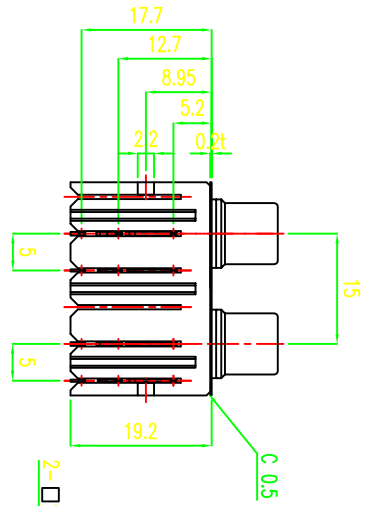
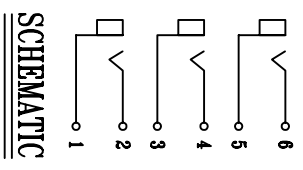
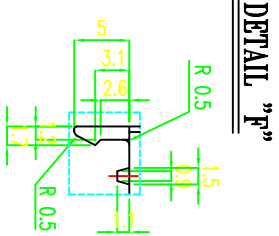
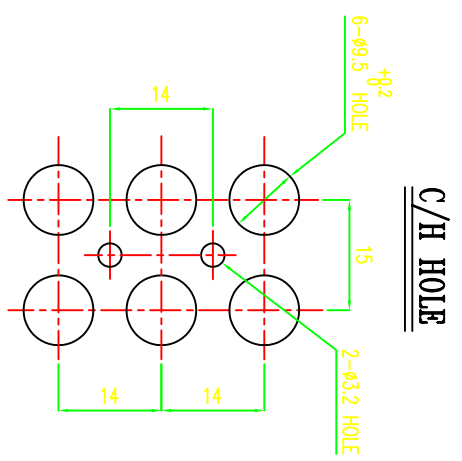
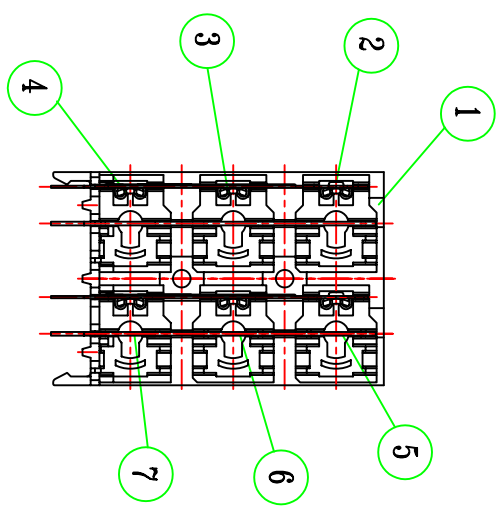
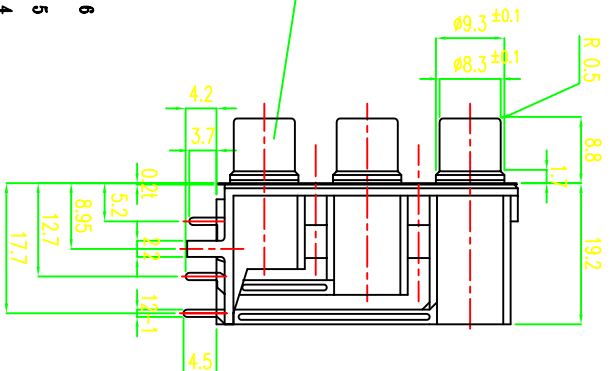
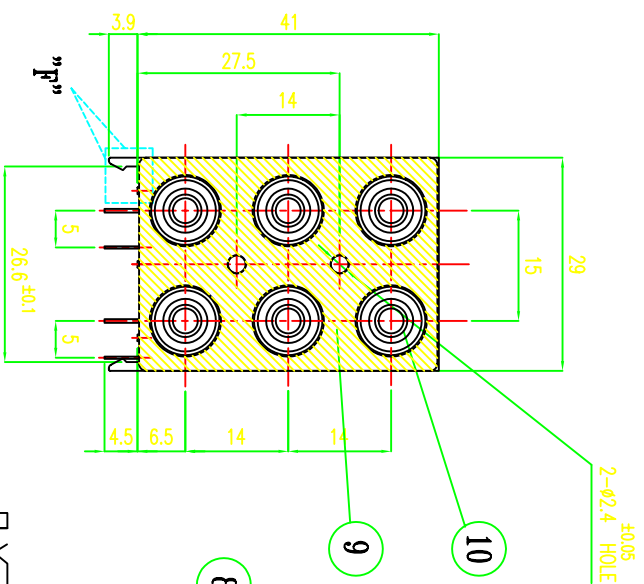

PCB MTG  
(Solder surface)

COLOR	Y	Y
W: WHITE	W	W
B: BLACK	W	W
R: RED	R	R
Y: YELLOW	R	R

NO	PART NAME	MATERIAL	QUANTITY	PART NO	REMARKS
10	WASHER	ABS 94HB	6	2M634	
9	GND-PLATE	C2660 1/2H 0.2t	1	2P337	NI-PLATING
8	CAP	C2660 1-0 0.3t	6	1P065	NI-PLATING
7	PIN-S	C2660 1/2H 0.5t	2	2P288	Sn-PLATING
6	PIN-M	C2660 1/2H 0.5t	2	2P287	Sn-PLATING
5	PIN-L	C2660 H 0.5t	2	2P286	Sn-PLATING
4	GND TER'-S	C2660 1/2H 0.3t	2	2P315	Sn-PLATING
3	GND TER'-M	C2660 1/2H 0.3t	2	2P314	Sn-PLATING
2	GND TER'-L	C2660 1/2H 0.3t	2	2P313	Sn-PLATING
1	BASE	ABS 94HB	1	2M774	BLACK

Vimex International Corp.		SCALE 1/1		DIMENSION mm/cm	
http://www.vimex.com		PIN JACK BOARD(6P)			
REVISION	DRAWING	CHECKED	APPROVED	DRAWING NUMBER	JB060015PN
1.1	L.M.S				
1999.07.01			1999.07.01		