

16mm Metal Shaft Rotary Potentiometer (Ceramic)

CE16TM1

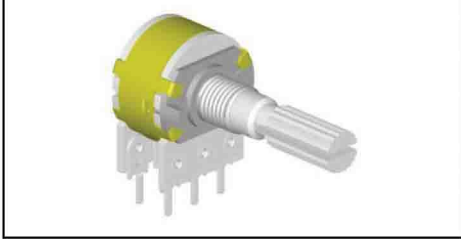

Part Number
CE16TM1 – B 50K, L- 20 KC

↓ Taper r
 ↓ Resistance value
 ↓ Shaft Length
 ↓ Shaft Type

Dimensions

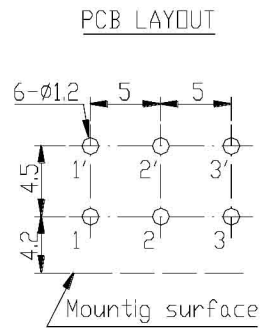
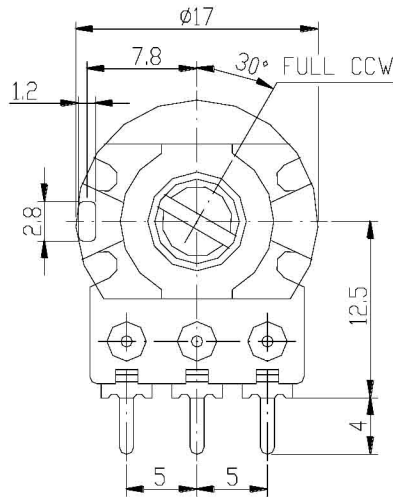
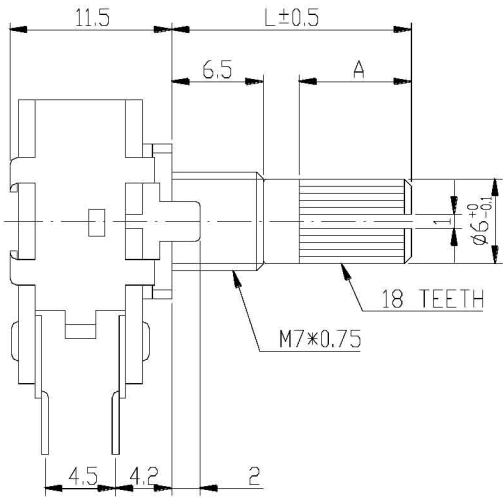

CIRCUIT

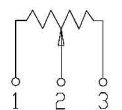

Shaft Type

KC/CI Type

KC Type

R Type

RE Type

F Type

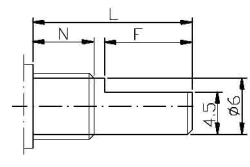
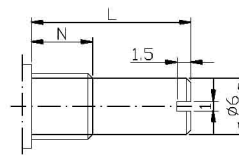
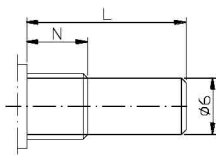
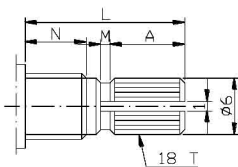
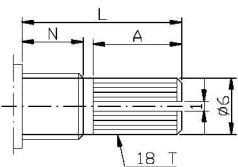

		N=6.5 mm								
Shaft Type		L	10	15	17	20	25	30	35	40
KC	A	2.2	6	8	10	12	12	12	12	12
	C	0.5	1	1	2	2	4	4	4	4
KC/CI	A	1.5	6.5	8.5	11.5	14	19			
R	L	10	15	17	20	25	30	35	40	
RE	L	10	15	17	20	25	30	35	40	
F	F	2.5	7	7	12	12	12	12	12	

		N=5 mm								
Shaft Type		L	10	15	17	20	25	30	35	40
KC	A	3.2	6	8	12	12	12	12	12	12
	C	0.5	1	1	2	2	4	4	4	4
KC/CI	A		8	10	13					
R	L	10	15	17	20	25	30	35	40	
RE	L	10	15	17	20	25	30	35	40	
F	F	4	7	7	12	12	12	12	12	