

ALLOWANCE	MARK	DATE	DESCRIPTION OF REVISION	APPROVED
UNDER 3	± 0.1	△	. .	
3 TO 6	± 0.2	△	. .	
6 TO 18	± 0.3	△	. .	
18 TO 50	± 0.4	△	. .	
50 OVER	± 0.5	△	. .	

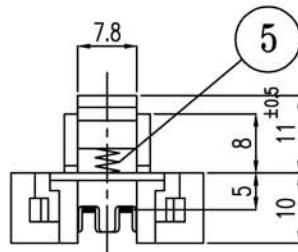

PCB-MTG
(Solder surface)

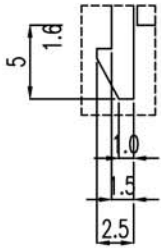
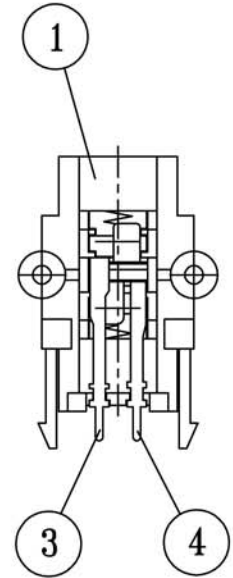
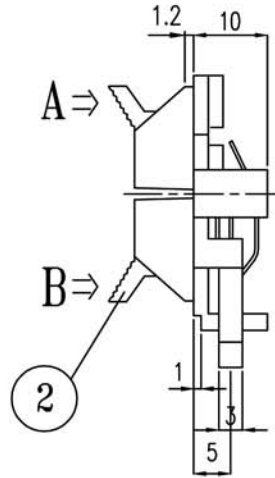
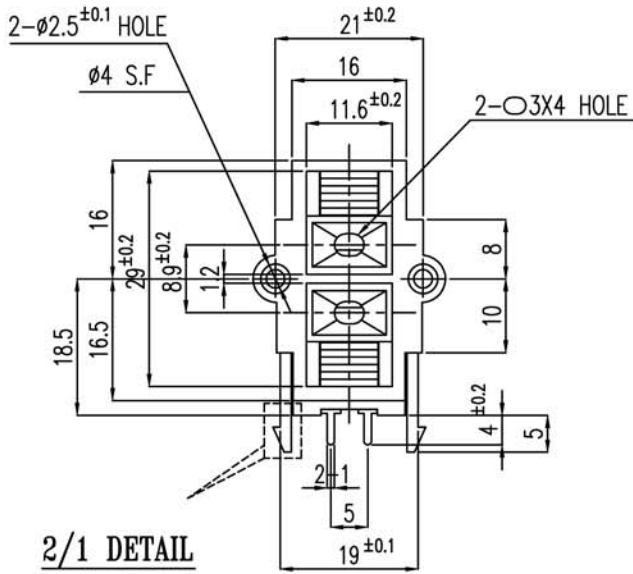
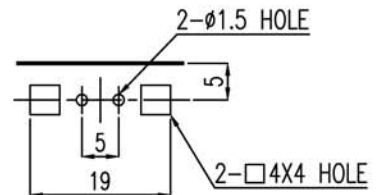

5	SPRING	SWRH	∅0.55t	2	1SP804	RUSTPROOF-TREATMENT
4	TERMINAL-S	C2680	1/2H 0.6t	1	2P082	SN -PLATING
3	TERMINAL-L	C2680	1/2H 0.6t	1	2P081	SN -PLATING
2	KNOB	ABS	94HB	2	2M657	A: B B: R
1	BASE	ABS	94HB	1	2M629	BLACK

NO	PART NAME	MATERIAL	QUANTITY	PART NO	REMARKS
----	-----------	----------	----------	---------	---------

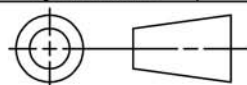

SCALE 1/1 DIMENSION m/m

REVISION	DRAWING	CHECKED	APPROVED	NAME TITLE	PUSH TER' BOARD(2P)
1.1				DRAWING NUMBER	P40220430P
	2002.02.04	2002.02.04	2002.02.04		